

Sistema modulare di imbottiti

Struttura portante in metallo verniciato a polveri epossidiche .

Seduta : multistrato, poliuretano indeformabile e fodera accoppiata con ovatta poliesteri.

Schienale : poliuretano stampato

Imbottitura interna resistente al fuoco secondo la normativa Italiana Classe 1 IM ed EN1021-1/2:2014

Rivestimento: tessuto, pelle, similpelle o tessuto cliente preferibilmente tinta unita.



	Articolo	Rivestimento	Solo Seduta	Seduta + 1 schienale	Seduta + 2 schienali	Seduta + 3 schienali	pezzi / misure volume / peso lordo/ peso netto articolo
Modulo 1 posto	Da I340	Gazebo					1 pz / 80x83x53 cm 0,35 m ³ / 25Kg 18 Kg
	A I341	Xtreme Plus / Magnum / Rivet / Main Line Flax Blazer / Gingko / Step Melange / Silvertex / Remix3 Steelcut Trio3 / Atlas / Canvas2 Pelle Pelle Cliente Materiale cliente (tinta unita)					Schienale 1 pz 83x26x112,5cm 0,24 m ³ / 18 Kg 14,5 Kg
Modulo 1,5 posti	Da I342	Gazebo					1 pz / 135x83x53cm 0,53 m ³ / 34 Kg 26,5 Kg
	A I344	Xtreme Plus / Magnum / Rivet / Main Line Flax Blazer / Gingko / Step Melange / Silvertex / Remix3 Steelcut Trio3 / Atlas / Canvas2 Pelle Pelle Cliente Materiale cliente (tinta unita)					Schienale 1 pz 83x26x112,5cm 0,24 m ³ / 18 Kg 14,5 Kg
Modulo 3 posti	Da I345	Gazebo					1 pz / 239x83x53 cm 1,1 m ³ / 68Kg 60 Kg
	A I358	Xtreme Plus / Magnum / Rivet / Main Line Flax Blazer / Gingko / Step Melange / Silvertex / Remix3 Steelcut Trio3 / Atlas / Canvas2 Pelle Pelle Cliente Materiale cliente (tinta unita)					Schienale 1 pz 83x26x112,5cm 0,24 m ³ / 18 Kg 14,5 Kg
Modulo curvo	Da I359	Gazebo					1 pz / 216x150x53 cm 1,62 m ³ / 63 Kg 55 Kg
	A I367	Xtreme Plus / Magnum / Rivet / Main Line Flax Blazer / Gingko / Step Melange / Silvertex / Remix3 Steelcut Trio3 / Atlas / Canvas2 Pelle Pelle Cliente Materiale cliente (tinta unita)					Schienale 1 pz 83x26x112,5cm 0,24 m ³ / 18 Kg 14,5 Kg

Dimensioni

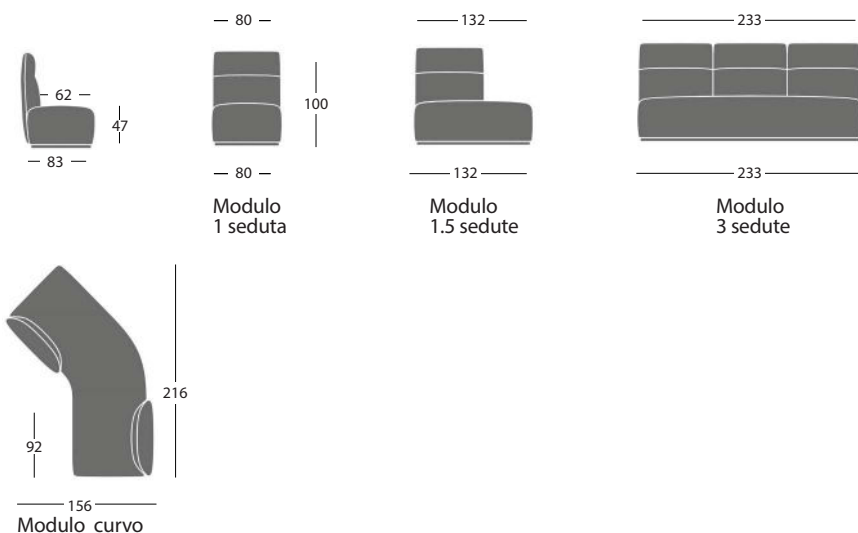

Supplementi: (Contattare Ufficio Commerciale)

- rivestimento in due tessuti diversi
- possibilità di elettrificazione

Materiale cliente

Per l'invio di materiale cliente si rinvia all'apposito modulo a fine listino da ritornare a Segis Spa corredato della firma del cliente

Modulo 1 posto

Consumo tinta unita per 1 pz.330 cm (H.140 cm)
Consumo pelle tinta unita per 1 pz 6 m²

Modulo 1.5 posti

Consumo tinta unita per 1 pz. 400 cm (H.140 cm)
Consumo pelle tinta unita per 1 pz 7,30 m²

Modulo 3 posti

Consumo tinta unita per 1 pz. 500 cm (H.140 cm)
Consumo pelle tinta unita per 1 pz 9,10 m²

Modulo curvo

Consumo tinta unita per 1 pz. 600 cm (H.140 cm)
Consumo pelle tinta unita per 1 pz 11 m²

Schienale

Consumo tinta unita per 1 pz. 220 cm (H.140 cm)
Consumo pelle tinta unita per 1 pz 4 m²

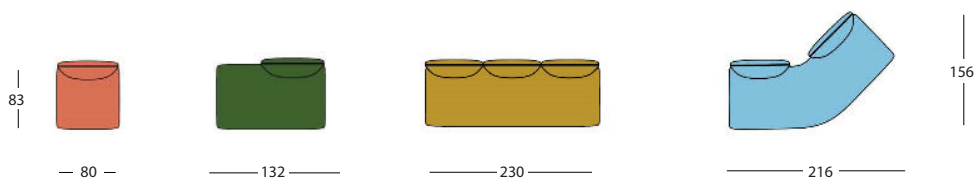

I340



I341



I342



I343



I344



I345



I346



I347



I348



I349



I350



I351



I352



I353



I354



I355



I356



I357



I358

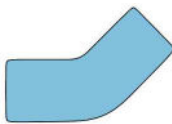

I359



I360



I361

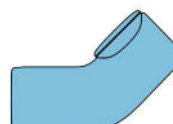

I362

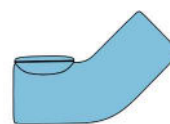

I363

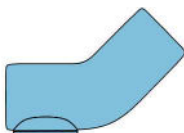

I364

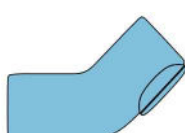

I365



I366

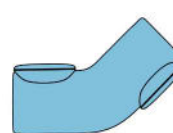

I367

Finiture

Struttura metallo

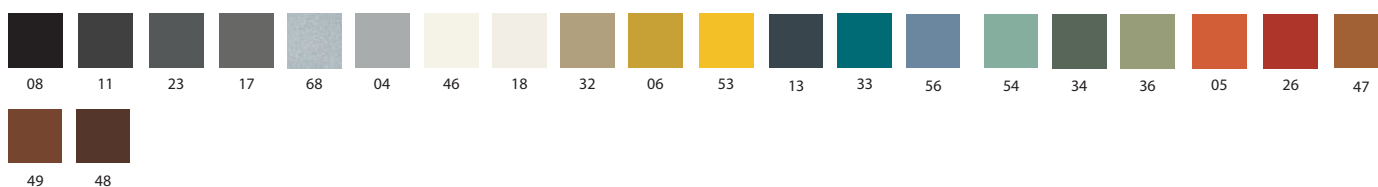

Tavolino multifunzione con piano girevole .
Struttura: Metallo con finitura verniciata a polveri epossidiche .
Piano: laminato HPL Ø 40 cm

Il tavolo si può montare in qualsiasi posizione lungo il perimetro della seduta



Articolo

pezzi / misure
 volume / peso lordo/
 peso netto articolo

Tavolo Ø 40 cm

MTAVSKY

1 pz / 42x67x12cm
 0,03 m³ / 7 Kg
 4 Kg

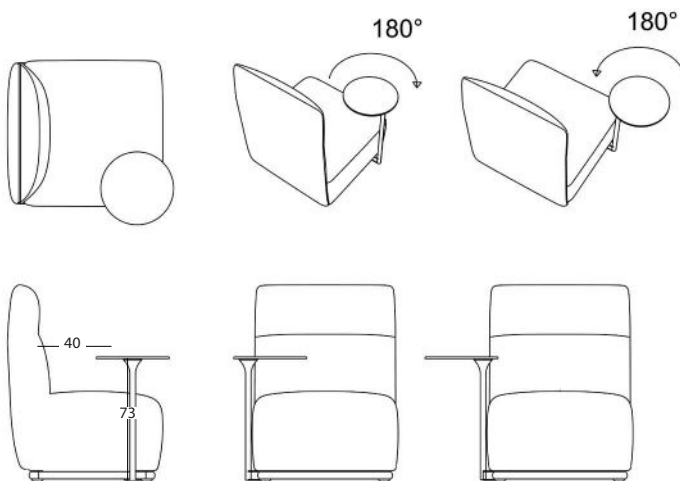

Finiture

Struttura metallo



08 18

Piani

HPL



BI NR*